

High-speed switching diode

- . 500mW DO-35
- . Glass silicon switching diodes
- . We declare that the material of product compliance with RoHS requirements.

1N4148

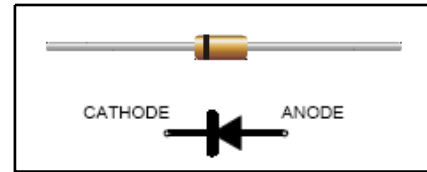

Product Characteristic

Absolute Maximum Ratings ($T_a = 25^\circ\text{C}$)

	Symbol	Value	Unit
Reverse Voltage	V_R	75	V
Peak Reverse Voltage	V_{RM}	100	V
Rectified Current (Average) Half Wave Rectification with Resist Load at $T_{amb} = 25$ and $f = 50\text{HZ}$	I_o	150 ¹⁾	mA
Surge Forward Current at $t < 1\text{s}$ and $T_j = 25$	I_{FSM}	500	mA
Power Dissipation at $T_{amb} = 25$	P_{tot}	500 ¹⁾	mW
Junction Temperature	T_j	175	
Storage Temperature Range	T_s	-65 to +175	

¹⁾ Valid provided that leads at a distance of 8mm from case are kept at ambient temperature

Characteristics at $T_a = 25^\circ\text{C}$

	Symbol	Min.	Typ.	Max.	Unit
Forward Voltage at $I_F = 10\text{ mA}$	V_F	—	—	1	V
Leakage Current at $V_R = 20\text{ V}$ at $V_R = 75\text{V}$ at $V_R = 20\text{ V}$, $T_j = 150$	I_R	—	—	25	nA
	I_R	—	—	5	μA
	I_R	—	—	50	μA
Reverse Breakdown Voltage tested with 100 μA Pulses	$V_{(BR)R}$	100	—	—	V
Capacitance at $V_F = V_R = 0\text{V}$	C_{tot}	—	—	4	pF
Voltage Rise when Switching ON tested with 50 mA Forward Pulses $t_p = 0.1\text{ s}$, Rise Time $< 30\text{ns}$, $f_p = 5$ to 100kHz	V_{fr}	—	—	2.5	V
Reverse Recovery Time from $I_F = 10\text{ mA}$ to $I_R = 1\text{mA}$, $V_R = 6\text{V}$, $R_L = 100\Omega$,	t_{rr}	—	—	4	ns
Thermal Resistance Junction to Ambient Air	R_{thA}	—	—	0.35 ¹⁾	K/mW ¹⁾
Rectification Efficiency at $f = 100\text{ MHz}$, $V_{RF} = 2\text{V}$	η_v	0.45	—	—	—

¹⁾ Valid provided that leads at a distance of 8mm from case are kept at ambient temperature

. Characteristic Curves

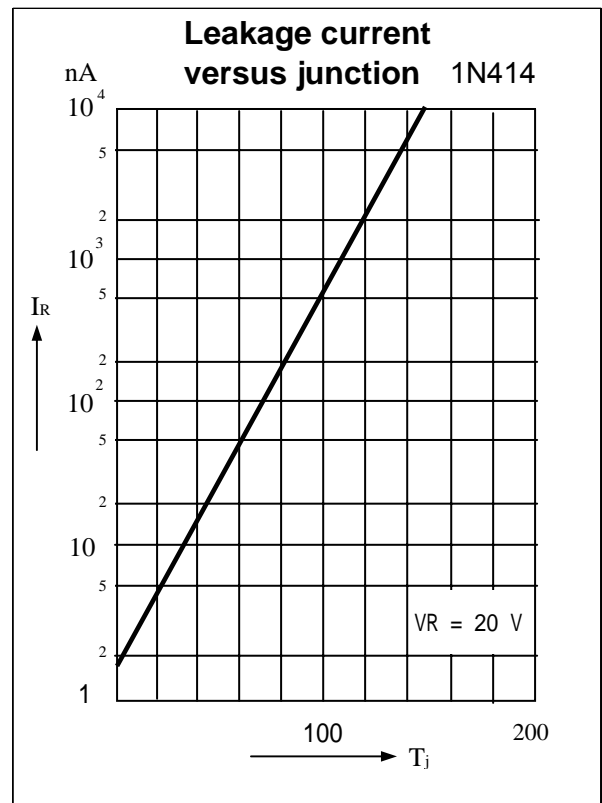
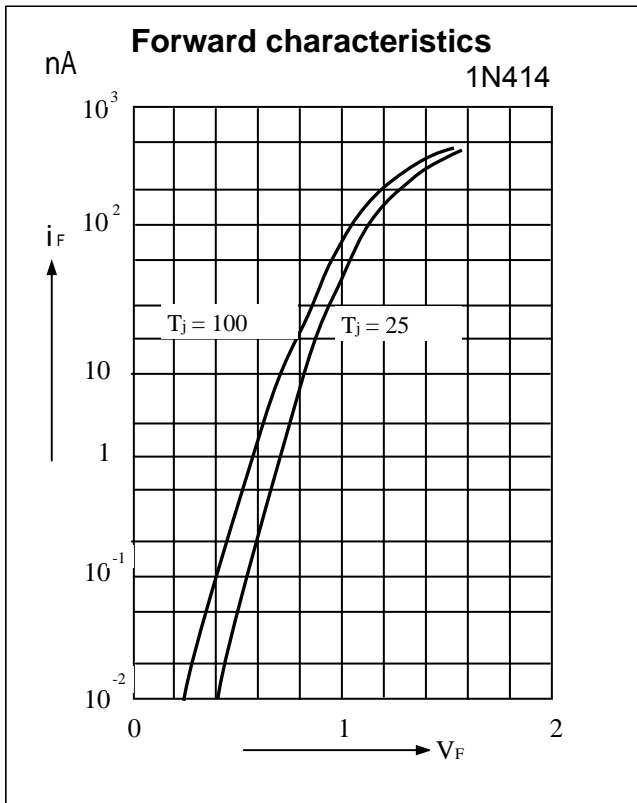

Package Dimensions in inches and (millimeters)

DIM	MILLIMETERS		INCHES	
	MIN	MAX	MIN	MAX
A	3.6	4.0	0.14	0.157
B	1.6	2.0	0.063	0.079
D	0.4	0.6	0.016	0.024
K	28	30	1.102	1.181

D0-35

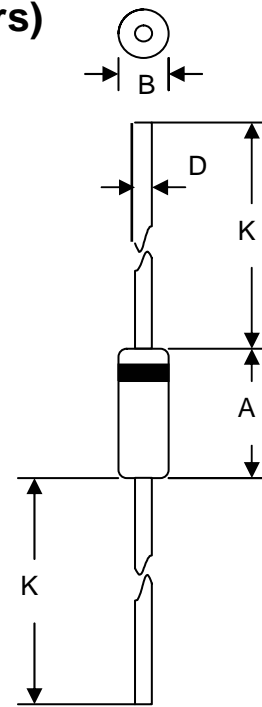

D0-35

Packing

Taping / Box(T52)

Tape Inner Box:5000pcs/each

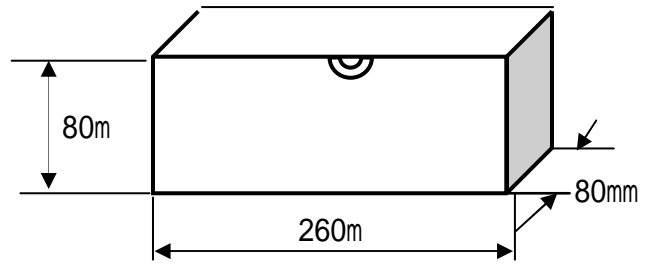

Taping / Box(T26)

Tape Inner Box:5000pcs/each

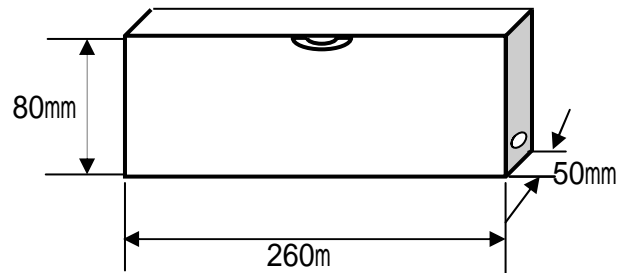

Bulk

500pcs/bag

10000pcs /each

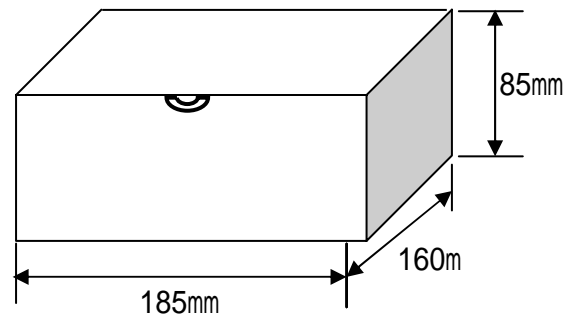

Reel (T52)

10000pcs/卷

